

3 MAIN CHARACTERISTICS, SEALS and HYDRAULIC FLUID - for other fluids not included in below table, consult our technical office

Assembly position / location	Any position		
Subplate surface finishing	Roughness index Ra 0,4 - flatness ratio 0,01/100 (ISO 1101)		
MTTFd values according to EN ISO 13849	150 years, for further details see technical table P007		
Ambient temperature	Standard execution = -30°C ÷ +70°C /PE option = -20°C ÷ +70°C /BT option = -40°C ÷ +70°C		
Seals, recommended fluid temperature	NBR seals (standard) = -20°C ÷ +60°C, with HFC hydraulic fluids = -20°C ÷ +50°C FKM seals (/PE option) = -20°C ÷ +80°C HNBR seals (/BT option) = -40°C ÷ +60°C, with HFC hydraulic fluids = -40°C ÷ +50°C		
Recommended viscosity	15 ÷ 100 mm ² /s - max allowed range 2.8 ÷ 500 mm ² /s		
Fluid contamination class	ISO 4406 class 21/19/16 NAS 1638 class 10, in line filters of 25 µm (β ₂₅ ≥ 75 recommended)		
Hydraulic fluid	Suitable seals type	Classification	Ref. Standard
Mineral oils	NBR, FKM, HNBR	HL, HLP, HLPD, HVLP, HVLPD	DIN 51524
Flame resistant without water	FKM	HFDU, HFDR	ISO 12922
Flame resistant with water	NBR, HNBR	HFC	

4 DIAGRAMS OF HR-0 based on mineral oil ISO VG 46 at 50°C

Flow through check valve:

- 1 = A→A₁; B→B₁ of
HR-012, HR-013, HR-014
- 2 = A₁→A; B₁→B of
HR-012, HR-013, HR-014
- 3 = HR-011, HR-016

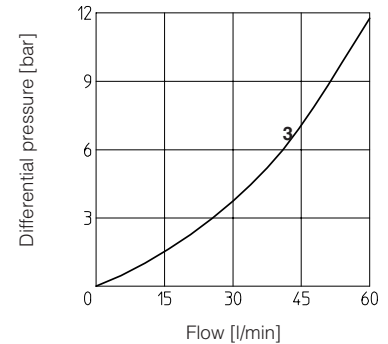
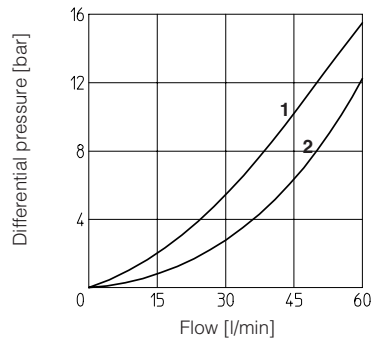

5 DIAGRAMS OF KR-0 based on mineral oil ISO VG 46 at 50°C

Flow through check valve:

- 1 = A→A₁; B→B₁ of
KR-012, KR-013, KR-014
- 2 = A₁→A; B₁→B of
KR-012, KR-013, KR-014
- 3 = KR-011, KR-016

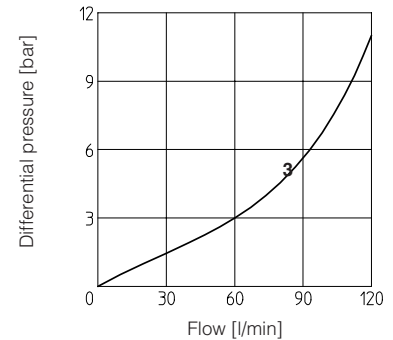
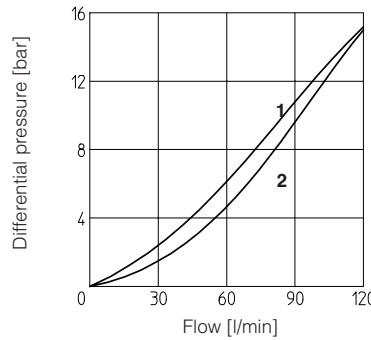

6 DIAGRAMS OF JPR-2 based on mineral oil ISO VG 46 at 50°C

Flow through check valve:

- 1 = A→A₁; B→B₁ of
JPR-212, JPR-213, JPR-214
- 2 = A₁→A; B₁→B of
JPR-212, JPR-213, JPR-214

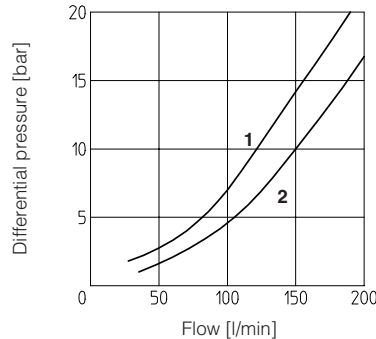

7 DIAGRAMS OF JPR-3 based on mineral oil ISO VG 46 at 50°C

Flow through check valve:

- 1 = A→A₁; B→B₁ of
JPR-312, JPR-313, JPR-314
- 2 = A₁→A; B₁→B of
JPR-312, JPR-313, JPR-314

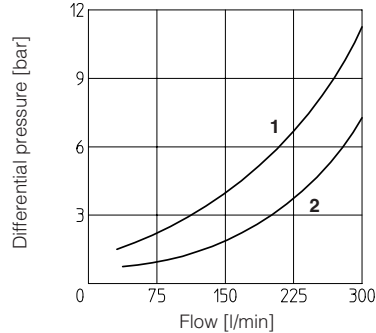

8 INSTALLATION DIMENSIONS OF HR-0 VALVES [mm]

HR-002
HR-003
HR-004
HR-012
HR-013
HR-014

LATERAL VIEW

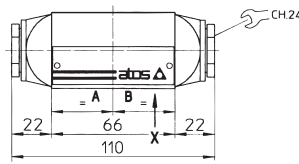
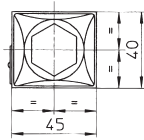

Mass: 1 Kg

HR-011
HR-016

LATERAL VIEW

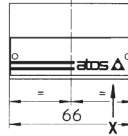
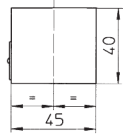

Mass: 0,7 Kg

ISO 4401: 2005

Mounting surface: 4401-03-02-0-05

Diameter of ports A, B, P, T: $\varnothing = 7,5$ mm (max)

Seals: 4 OR 108

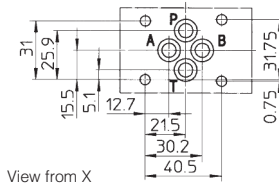

View from X

Fastening bolts: n° 4 socket head screws M5. The lenght depends on number and type of modular elements associated.

9 INSTALLATION DIMENSIONS OF KR-0 VALVES [mm]

KR-012
KR-002
KR-003
KR-004
KR-013
KR-014

LATERAL VIEW

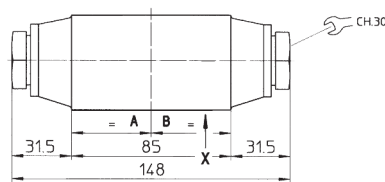
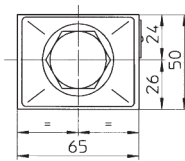

Massa: 2,3 Kg

KR-016

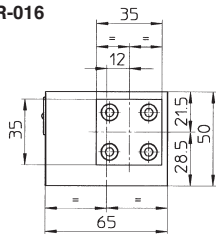

Mass: 2,5 Kg

LATERAL VIEW

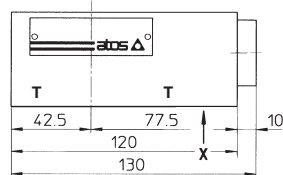

KR-011

LATERAL VIEW

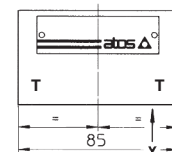
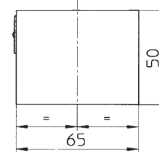

Mass: 1,7 Kg

ISO 4401: 2005

Mounting surface: 4401-05-04-0-05

Diameter of ports A, B, P, T: $\varnothing = 11,2$ mm (max)

Seals: 5 OR 2050

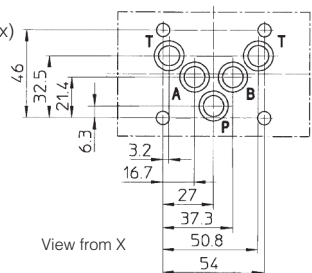

View from X

Fastening bolts: n° 4 socket head screws M6. The lenght depends on number and type of modular elements associated.

10 INSTALLATION DIMENSIONS OF JPR-2 VALVES [mm]

JPR-212
JPR-213
JPR-214

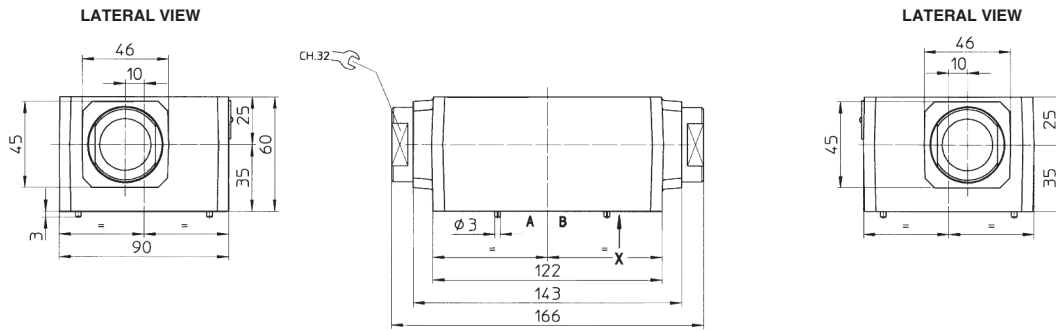

Mass: 4,4 Kg

ISO 4401: 2005

Mounting surface: 4401-07-07-0-05

Diameter of ports A, B, P, T: $\varnothing = 20$ mm

Diameter of ports X, Y: $\varnothing = 7$ mm

Seals: 4 OR 130; 2 OR 109

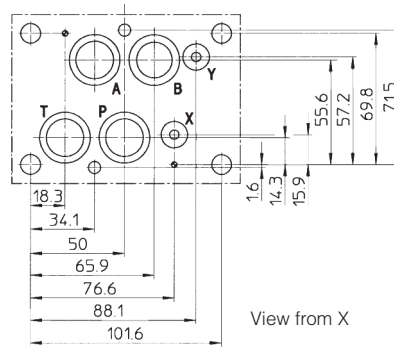

View from X

Fastening bolts: n° 4 socket head screws M10 and n° 2 M6. The length depends on number and type of modular elements associated.

11 INSTALLATION DIMENSIONS OF JPR-3 VALVES [mm]

JPR-312
JPR-313
JPR-314

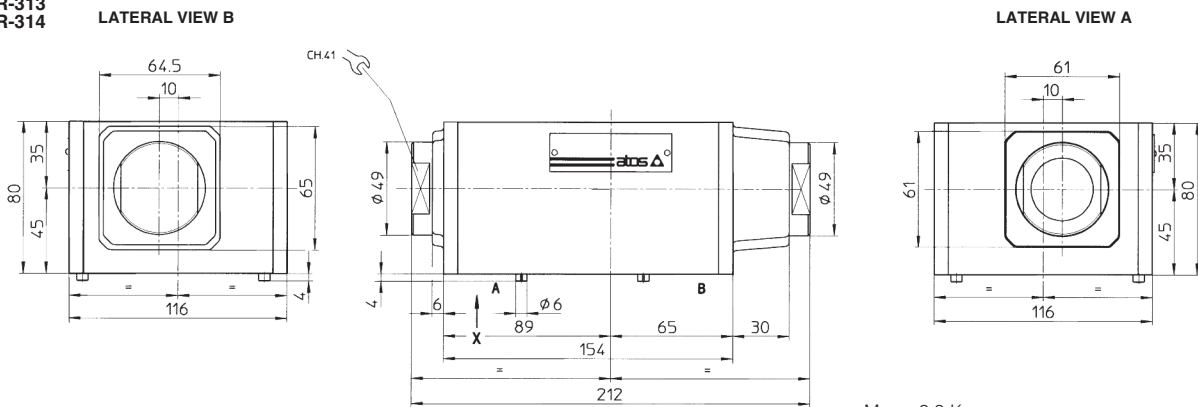

Mass: 9,9 Kg

ISO 4401: 2005

Mounting surface: 4401-08-08-0-05

Diameter of ports A, B, P, T: $\varnothing = 24$ mm

Diameter of ports X, Y: $\varnothing = 7$ mm

Seals: 4 OR 4112; 2 OR 3056

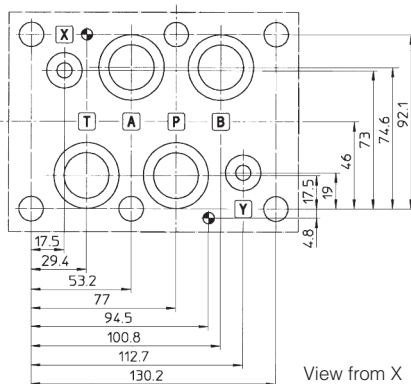

View from X

Fastening bolts: n° 6 socket head screws M12. The length depends on number and type of modular elements associated.